

# BRAUN

Multiquick®  
Professional  
Fresh System

MR 5550 M CA V

## 德国博朗

多功能快速食品  
调理组合

MR5550 M CA V

### 使用说明书



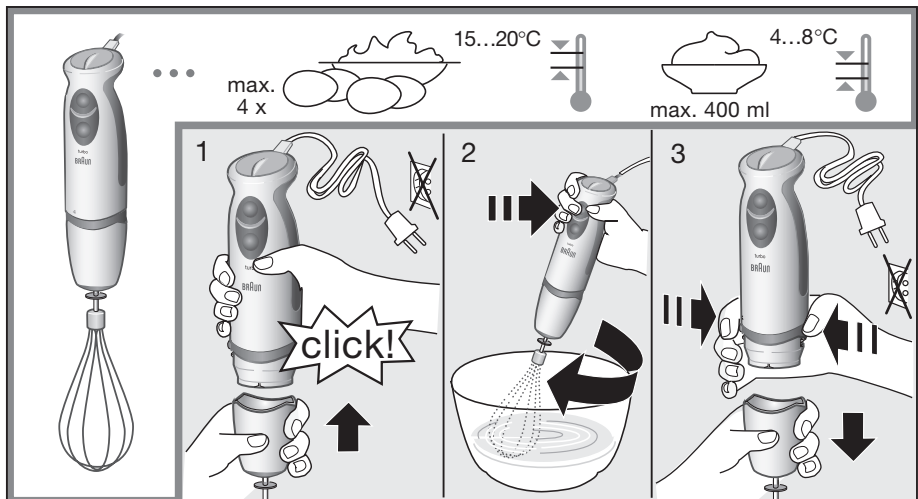
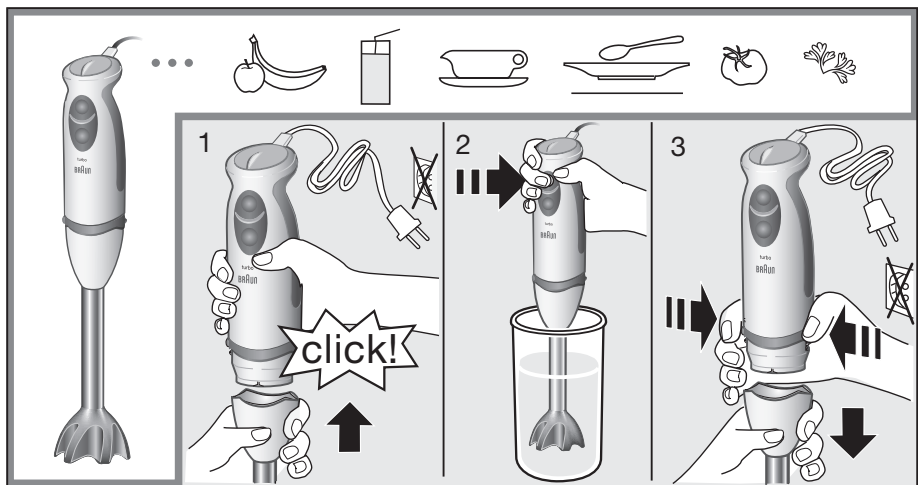
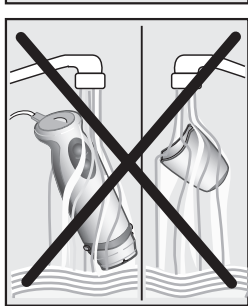
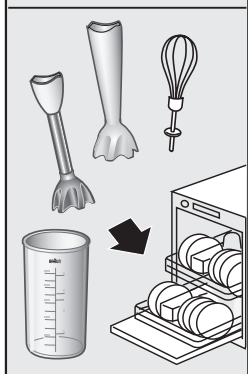
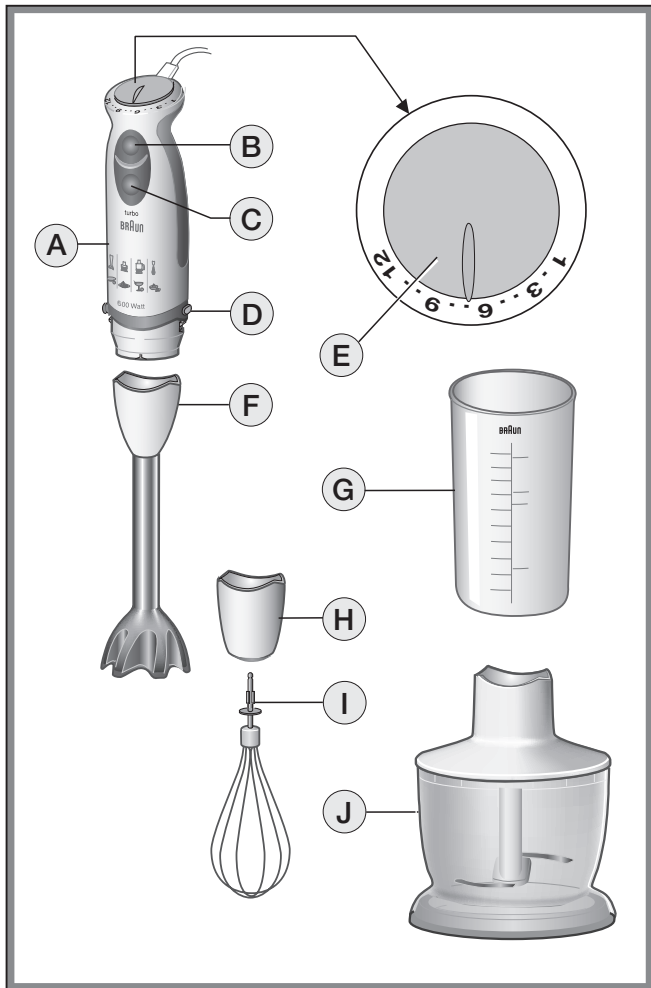

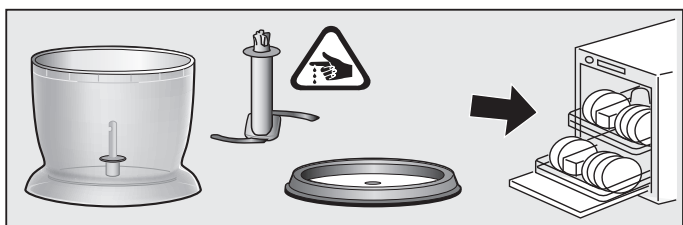
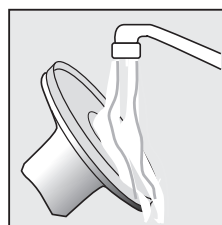
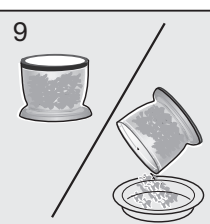
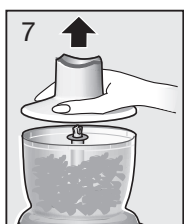
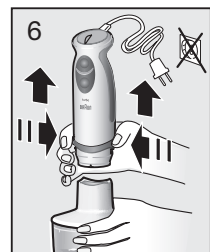
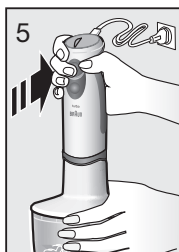
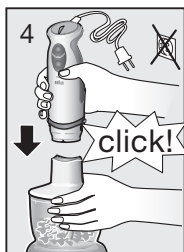
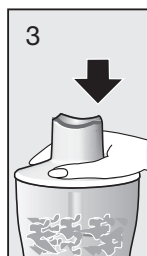
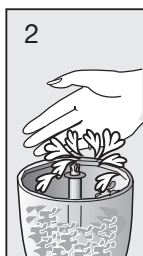
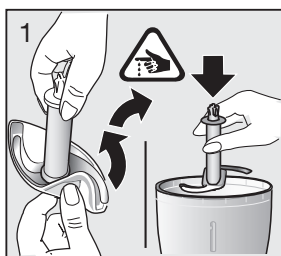
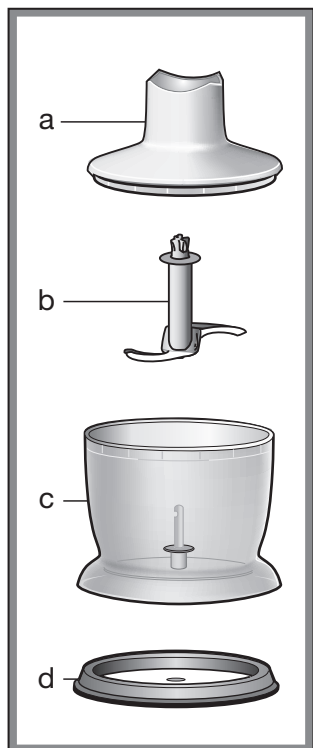

		max.	⌚ +/-		
	(2cm)	300 g	15-30 sec		turbo
	(1cm)	200 g	30 sec		turbo
		200 g	10 sec	1 - 4	
		30 g	20 sec		turbo
		20	20 sec	1 - 7	
		200 g	15 sec	1 - 7	
		300 g	25 sec	8 - 12	
		350 g	30 sec	8 - 12	

# 中文 MR5550 M CA 多功能快速食品调理组合

使用本产品前请仔细阅读完整的使用说明。

本产品设计精良，功能完善，质量可靠，能满足高标准的要求。希望您能喜欢新款博朗产品。

## 注意事项

- 刀片非常锋利，使用时请小心！
- 组装、拆卸、清洗或储藏本产品前，请务必先切断电源。
- 本产品应放置于儿童无法触及的地方。
- 请勿将电机部件(A)或搅拌器齿轮箱(I)放在流水下或浸入水中清洗。
- 博朗电器符合适用的安全标准。必须由授权服务人员维修或更换电源线。维修不当或错误维修可能引发事故，使用户受伤。
- 在接通电源前，请确保您使用的电压与本产品底部所标明的电压一致。
- 本产品的的设计容量满足一般家庭用量。使用切碎钵(c)时，应先放刀片(b)，再放食物进行操作。
- 量杯(G)及切碎钵(c)均不可放在微波炉或烤箱中使用。切碎钵(c)不可进行高温消毒。
- 切勿连续长时间开动手柄马达，以免烧毁电机。

## 组件说明

- (A) 电机部件
- (B) 变速开关
- (C) 涡轮速度调节开关
- (D) 工作部件释放按钮
- (E) 变速调节器
- (F) 搅拌机传动轴
- (G) 带有密封盖的量杯
- (H) 搅拌器齿轮箱
- (I) 搅拌器
- (J) 切碎器

## 使用方法

### 设置速度

打开开关(B)后，本产品将以变速调节器(E)所设定的速度进行食品处理。设定的速度越高，切碎的速度越快。

然而，只有在按下涡轮开关(C)后才能取得最快的处理速度。您也可使用涡轮开关直接获得高强度脉冲，而无需使用变速调节器。

建议采用以下速度设置，具体情况取决于您所购买产品的功能：

手控搅拌杆	1档 + 涡轮开关(C)
切碎器	1档 + 涡轮开关(C)
搅拌器	2档至4档

### 如何使用手控搅拌杆

手控搅拌杆特别适合制作沾酱、酱汁、汤、蛋黄酱、婴儿食品以及混合饮料和奶昔。

- 将电机部件(A)插入搅拌杆的传动轴(F)中，直至锁紧。
- 将手控搅拌杆放入容器中，按下开关(B)或涡轮开关(C)。
- 使用后按住按钮(D)，即可松开搅拌杆的传动轴，将其拔下。

可在量杯以及其他各种容器中使用手控搅拌杆。在炖锅中使用时，请先将炖锅从炉子上取下来，以防您的手控搅拌杆因过热而造成损坏。

### 如何使用搅拌器(I)

搅拌器仅适用于打发奶油、打散蛋白以及混合海绵蛋糕与预拌好的甜点。

- 将搅拌器(I)插入搅拌器齿轮箱(H)中，然后将电机部件(A)插入齿轮箱，直至锁紧。
- 将搅拌器放入容器内，接着按下开关(B)，即可开始使用。
- 如需取下搅拌器，只需按下释放按钮，拔出齿轮箱，然后将搅拌器从齿轮箱中取出即可。

为获得最佳效果：

- 请使用较大的容器。
- 每次最多打发400毫升冷冻奶油（脂肪含量最低为30%，4-8°C）。
- 每次打散的蛋白数量不超过4个。
- 使用搅拌器时以顺时针方向搅动。

### 如何使用切碎器配件

- (a) 切碎器齿轮箱
- (b) 刀片
- (c) 切碎钵
- (d) 防滑底座/盖子

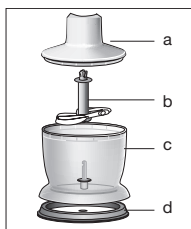

切碎器特别适合绞碎肉类、奶酪、洋葱、草药、蒜、胡萝卜、胡桃、榛子以及杏仁等食品。

如需切碎较硬的食物（如硬干酪）时，请使用涡轮开关(C)。

注：请勿使用本产品处理非常坚硬的食物，例如冰块、肉豆蔻、咖啡豆以及谷物等。

### 使用切碎器前.....

- 请预先将肉类、奶酪、洋葱、蒜以及胡萝卜等切成小块（见第3页图表）
- 去除草药的杆和未脱壳的种子
- 去除肉的骨头、肌腱以及软骨

- 警告：请小心取下刀片上的塑料套。刀片非常锋利！取下时始终握住刀片上部的塑料部分。将刀片放置在切碎钵的中心销上(c)。将其按下直至完全锁紧。使用时始终将切碎钵放置在防滑底座上(d)。
- 将食物放入切碎钵中。
- 将齿轮箱(a)放在切碎钵上。
- 将电机部件(A)插入齿轮箱(a)中直至完全锁紧。
- 按下开关(B)或(C)，启动切碎器。在处理的过程中，以单手握紧电机部件，另一只手固定住切碎钵。
- 使用完毕后，按下释放按钮(D)，取下电机部件。
- 然后移除齿轮箱。
- 小心地取出刀片。
- 然后将处理好的食物从切碎钵中取出。对于切碎钵而言，防滑底座同时也起到密封盖的作用。

## English

### 清洗

请使用湿布来清洁电机部件Ⓐ以及搅拌器齿轮箱Ⓕ。可将切碎器齿轮箱(a)放在水龙头下冲洗。请勿将齿轮箱(a)浸入水中。其他部件均可以使用洗碗机清洗。但在处理完盐分很高的食物后，应立即将刀片冲洗干净。同时，请注意不要在洗碗机中使用过量的清洁剂或除垢剂。

在处理有色食物时（如胡萝卜），本产品的塑料部分可能被染色。在将它们放入洗碗机清洗前，请为这些部件涂上植物油。

### 附件

（本产品的配件可在零售商或博朗服务中心处购买；但并非每个国家都设有零售商和博朗服务中心）

BC-5000: 切碎器附件，特别适合切碎大量食物、制作混合饮料、面糊以及碾碎冰块。

HC-5000: 高速切碎器，是切碎草药、洋葱、蒜、辣椒以及坚果的理想工具。

### 食谱样本

蛋黄酱（使用手动搅拌器）

200-250毫升油

1个鸡蛋（含蛋黄和蛋清）

1汤匙的柠檬汁或食醋，按照个人口味加入适量食盐以及胡椒粉。

按照以上顺序将所有原料依次加入搅拌杯中。将手动搅拌器放入搅拌杯的底部。按下涡轮开关Ⓒ，保持搅拌器位置不变，直至油脂乳化。接着，保持搅拌器打开状态，缓慢地上下移动搅拌器，直至蛋黄酱完全制成。

如有变化，恕不另行通知。

本产品符合欧洲共同体辐射控制条例 89/336/EEC和欧洲共同体低电压条例 2006/95/EC的要求。



Our products are engineered to meet the highest standards of quality, functionality and design. We hope you thoroughly enjoy your new Braun appliance.

### Caution

**Please read the use instructions carefully and completely before using the appliance.**

- The blades are very sharp!
- Always unplug the appliance before assembling, disassembling, cleaning or storing.
- The appliance must be kept out of reach of children.
- Do not hold the motor part Ⓐ nor the whisk gear box Ⓘ under running water, nor immerse them in water.
- Braun electric appliances meet applicable safety standards. Repairs or the replacement of the mains cord must only be done by authorised service personnel. Faulty, unqualified repair work may cause considerable hazards to the user.
- Before plugging into a socket, check whether your voltage corresponds to the voltage printed on the bottom of the appliance.
- The appliance is constructed to process normal household quantities.
- Neither the beaker Ⓕ, nor the chopper bowl (c) is microwave-proof.

### Description

- Ⓐ Motor part
- Ⓑ On/off switch for variable speed
- Ⓒ On/off switch for turbo speed
- Ⓓ Buttons for releasing the working parts
- Ⓔ Variable speed regulator
- Ⓕ Blender shaft
- Ⓖ Wall mount
- Ⓕ Measuring beaker with air-tight lid
- Ⓘ Whisk gear box
- Ⓙ Whisk
- Ⓚ Chopper

### Setting the speed

When activating switch Ⓑ, the processing speed corresponds to the setting of variable speed regulator Ⓔ. The higher the setting, the faster the chopping results.

However, maximum processing speed can only be achieved by pressing the turbo switch Ⓒ. You may also use the turbo switch for instant powerful pulses without having to manipulate the speed regulator.

Depending on the application, we recommend the following speed settings:

Handblender	1...turbo
Chopper	1...turbo
Whisk	2...4

### How to operate your handblender

The handblender is perfectly suited for preparing dips, sauces, soups, mayonnaise and baby food as well as for mixing drinks and milkshakes.

1. Insert the motor part Ⓐ into the blender shaft Ⓕ until it locks.
2. Introduce the handblender in the vessel, then press the on/off switch Ⓑ or the on/off turbo switch Ⓒ.
3. To release the blender shaft after use, press buttons Ⓓ and pull it off.

You can operate the handblender in the measuring beaker, and just as well in any other vessel. When blending directly in the saucepan while cooking, take the pan from the stove first to protect your handblender from overheating.

## How to operate your whisk

Use the whisk only for whipping cream, beating egg whites and mixing sponges and ready-mix desserts.

1. Insert the whisk ① into the whisk gear box ①, then insert the motor part ② into the gear box until it locks.
2. Place the whisk in a vessel and only then, press switch ③ to operate it.
3. To release, press buttons ④ and pull off the gear box. Then pull the whisk out of the gear box.

### For best results:

- Use a wide vessel.
- Only whip up to 400 ml chilled cream (min. 30 % fat content, 4–8 °C).
- Only whip up to 4 egg whites.
- Move the whisk clockwise.

## How to operate your chopper attachment

- (a) Chopper gear box
- (b) Blade
- (c) Chopper bowl
- (d) Anti-slip base/lid

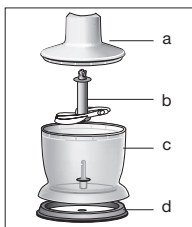

The chopper is perfectly suited for chopping meat, cheese, onions, herbs, garlic, carrots, walnuts, hazelnuts, almonds etc.

For chopping hard goods (e.g. hard cheese), use the on/off turbo switch ③.

**N.B.:** Do not chop extremely hard food, such as ice cubes, nutmeg, coffee beans, and grains.

### Before chopping...

- pre-cut meat, cheese, onions, garlic, carrots (see table page 3)
  - remove stalks from herbs, un-shell nuts
  - remove bones, tendons and gristle from meat.
1. Caution: Carefully remove the plastic cover from the blade. The blade is very sharp! Always hold it by the upper plastic part. Place the blade on the centre pin of the chopper bowl (c). Press it down until it locks. Always place the chopper bowl on the anti-slip base (d).
  2. Place the food in the chopper bowl.
  3. Put the gear box (a) on the chopper bowl.
  4. Insert the motor part ② into gear box (a) until it locks.
  5. Press switch ③ or ④ to operate the chopper. During processing, hold the motor part with one hand and the chopper bowl with the other.
  6. After use, press buttons ④ to remove the motor part.
  7. Then remove the gear box.
  8. Carefully take out the blade.
  9. Then remove the processed food from the chopper bowl. The anti-slip base also serves as an air-tight lid for the chopper bowl.

## Cleaning

Clean the motor part ② and the whisk gear box ① with a damp cloth only. The chopper gear box (a) may be rinsed under the tap. Do not immerse the gear box (a) in water. All other parts can be cleaned in the dishwasher. However, after processing very salty food, you should rinse the blades right away. Also, be careful not to use an overdose of cleaner or decalcifier in your dishwasher. When processing foods with colour (e.g. carrots), the plastic parts of the appliance may become discoloured. Wipe these parts with vegetable oil before placing them in the dishwasher.

## Accessories

(available at your retailer or at Braun Service Centres; however not in every country)  
BC-5000: Chopper attachment, perfectly suited for chopping large quantities as well as for preparing shakes, making light doughs and crushing ice cubes.  
HC-5000: High-speed chopper, ideal for herbs, onions, garlic, chilis, nuts etc.

## Recipe example

### Mayonnaise (use handblender)

200–250 ml oil

1 egg (yolk and white)

1 tbsp. lemon juice or vinegar, salt and pepper to taste

Put all ingredients into the beaker according to the a.m. order. Introduce the handblender to the base of the beaker. Pressing the turbo switch ③, keep the handblender in this position until the oil emulsifies. Then, without switching off, slowly move it up and down until the mayonnaise is well combined.

Subject to change without notice.

This product conforms to the European Directives EMC 2004/108/EC and Low Voltage 2006/95/EC.



## Guarantee

We grant 1 year guarantee on the product commencing on the date of purchase. Within the guarantee period we will eliminate, free of charge, any defects in the appliance resulting from faults in materials or workmanship, either by repairing or replacing the complete appliance as we may choose. This guarantee extends to every country where this appliance is supplied by Braun or its appointed distributor.

This guarantee does not cover: damage due to improper use, normal wear or use as well as defects that have a negligible effect on the value or operation of the appliance. The guarantee becomes void if repairs are undertaken by unauthorised persons and if original Braun parts are not used.

To obtain service within the guarantee period, hand in or send the complete appliance with your sales receipt to an authorised Braun Customer Service Centre.



# 最新Braun售后服务部地址

城市	公司名称	地址	联系电话	
<b>中区</b>				
200085	上海	安帮北站天路家用电器维修服务社	上海市永兴路540号(靠近西藏北路)	63566755/56329466
200235	上海	乐帮新尊办公设备维修服务社	上海市漕溪路190号(靠近田林东路)	64688241
201100	上海	上海市闵行区博杰家用电器维修部	上海市闵行区莘建东路210号(莘庄地铁站-北广场)	64122533
310016	杭州	杭州中侨家电维修服务有限公司	杭州市采荷路10号	86047438
215004	苏州	苏州家用电器维修服务中心有限公司	苏州市干将西路1168号	68662852
266071	青岛	青岛市市南区超维影视通讯技术服务部	青岛市南区银川西路3号政泰商务楼202室	85977910
361003	厦门	厦门市思明区新鹭声电子技术服务部	厦门后埭溪路248号之6、7、8号	5170118
210003	南京	南京博伊华电子电器经营部	南京市中山北路223号建达大厦(陆龙电子城)	83420092
214031	无锡	无锡新闻通信设备服务有限公司	无锡市五爱北路27号	82729805
315040	宁波	宁波市江东明楼甬城家电维修部	宁波市江东惊驾路506号	87771344
315000	宁波	宁波海曙创佳数码家电维修部	宁波市苗圃路39弄50号(海关对面)	87134422
250013	济南	济南历下安捷电子产品维修部	济南市历下区利农庄路29号	86994969
230001	合肥	合肥国升数码技术服务部	合肥市临泉路惠园小区6号楼108门面	2655887/2654456
450000	郑州	郑州晟辉商贸有限公司	郑州市兴隆街8号郑州大酒店B座2306室	66760659
330029	南昌	南昌市西湖区昌箭视听器材维修中心	南昌市西湖区新洲路98号	6786883
<b>北区</b>				
100078	北京	北京盛侨家电维修服务中心	北京市丰台区方庄芳群园2区6号楼金芳公寓304室	67698025/67630617
100035	北京	北京盛侨家电维修服务中心	北京市西城区德胜门内大街54号	66561976
050021	石家庄	河北省家电维修中心	石家庄市槐北路70号	86011793
300022	天津	天津市大东电器维修有限公司	天津市和平区滨江道109号	27120170/27120168
110011	沈阳	沈阳市沈河区大业电器维修中心	沈阳市沈河区承德路36-1	24870309
150010	哈尔滨	哈尔滨市道里区信誉进口家电维修部	哈尔滨市道里区地段街190号	84644674
116021	大连	大连市沙河口区现代电子技术服务部	大连市沙河口区西南路791号-7-3	86841988
130042	长春	吉林省百文礼品文具有限公司	长春市南关区大经路370号	88741702
710014	西安	陕西百利商贸有限公司	西安市丰禾路6号丰禾小区22号楼2楼	86220211
<b>南区</b>				
510600	广州	广州市金永利电器有限公司	广州市寺右新马路南二街24号	87386165(6)
518028	深圳	深圳市顺电连锁股份有限公司	深圳市华强北路上步工业区202栋2楼东	83286255
400014	重庆	重庆市渝中区中侨家电维修部	重庆市渝中区中山三路44号附2号	63527117
530001	南宁	南宁市南方家电维修中心	广西南宁市唐山路29号首层	3118895/3907787
650032	昆明	昆明松和电器有限公司	昆明市三合营路25号附2号	3645557
430015	武汉	武汉市江岸区兆利达家电维修中心	汉口解放大道1439号4栋3单元101室	85790611
410007	长沙	长沙市雨花区时代电器技术服务部	长沙市车站南路934号	4148005
610017	成都	成都市武侯区金维电子经营部	成都市大安东路57号3-6号	66656887
528200	佛山	佛山市禅城区得盛家电维修部	佛山市城门西商业街10号	83213535
350001	福州	福州福春电器维修服务有限公司	福州市塔头路328号顺意园一楼店面(福州锅炉厂对面)	87582122
325000	温州	温州市声像技术服务公司	温州市马鞍池东路45-47号	88850706/10187

上海涵思贸易有限公司可办理零件及产品邮购 电话: (021)64606449

E-mail: sp-order@hansi.sh.cn 邮编: 201100

注: 如果当地无特约维修站, 请与就近的维修站联系

固话免费咨询热线: 800-820-1357 手机用户咨询热线: 400-820-1357

**BRAUN**  
德国博朗

博朗(上海)国际贸易有限公司













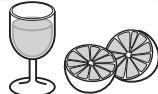
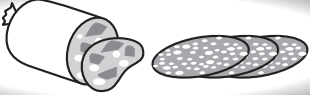

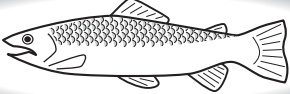
地址: 上海市外高桥保税区菲拉路55号综合楼第四层A部位

售后服务日常联系地址: 中国上海浦东三林路550号 邮编: 200124

上述售后服务部地址确定于2008年1月, 可能有不定期更新。如有疑问, 请咨询客户服务热线。

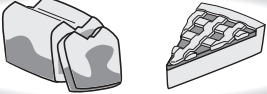
固话免费咨询热线: 800-820-1357 手机用户咨询热线: 400-820-1357

# Fresh System 保鲜温度

	+18 ... +25°C	-1 ... +7°C	min. -18°C
		●	●
		●	●
		●	●
		●	●
		●	●
		●	●
			●
		●	
		●	
		●	
	●	●	●
	●	●	●
	●	●	
	●		
	●		
	●		
	●		



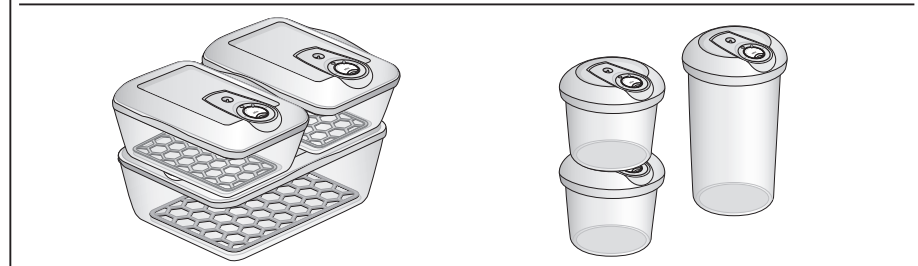
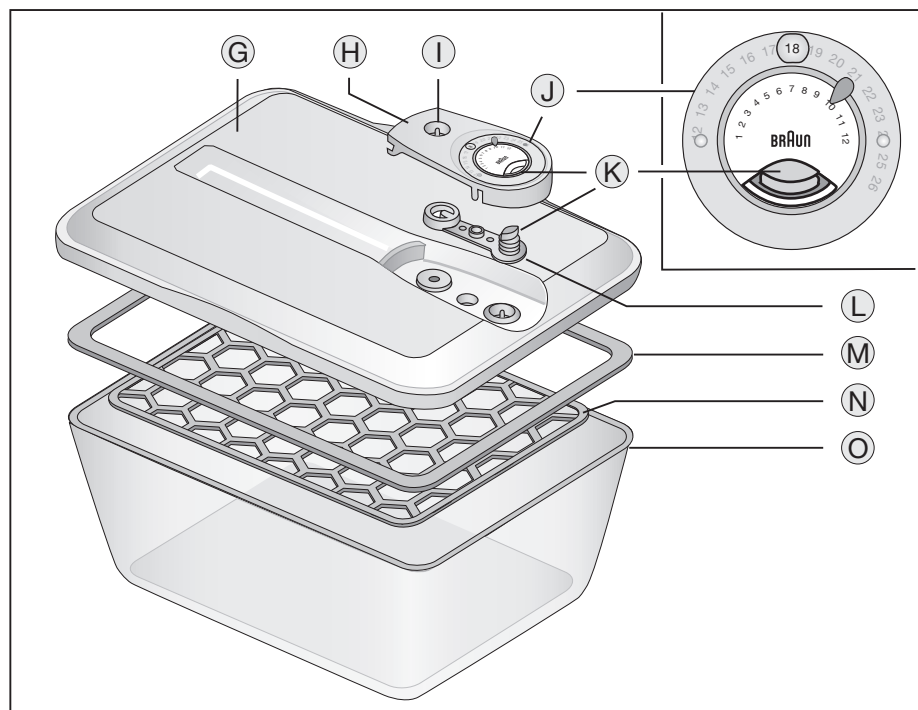
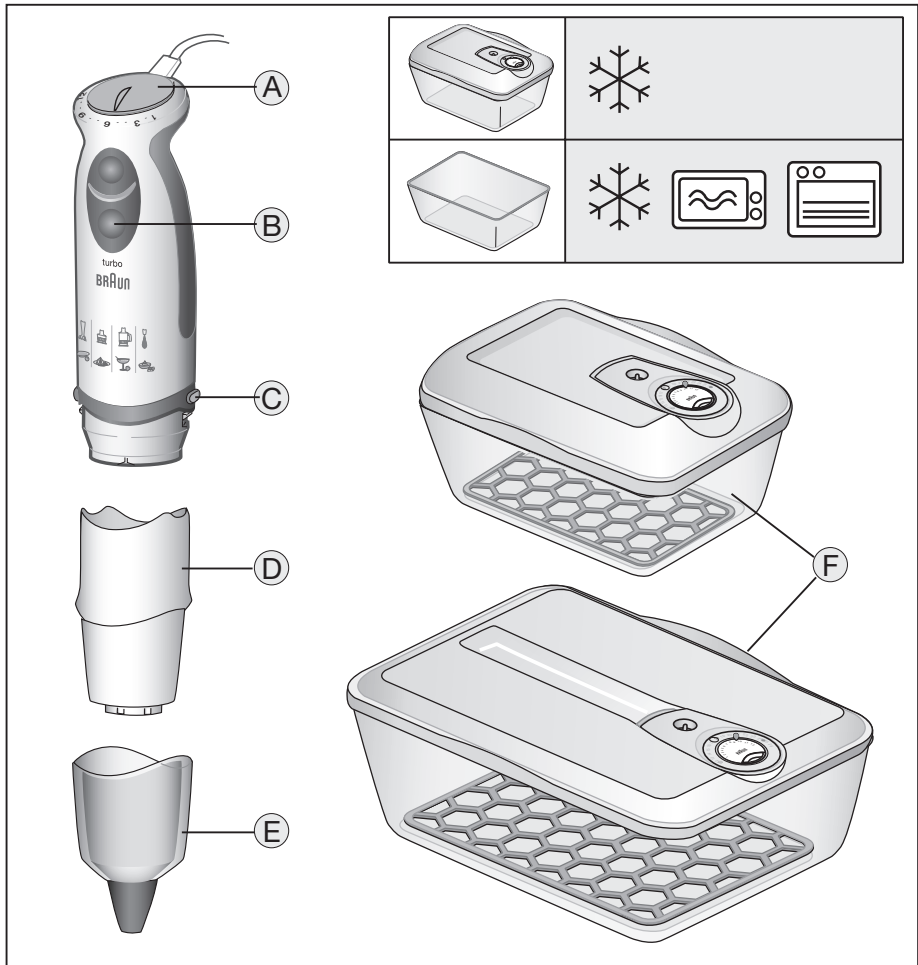

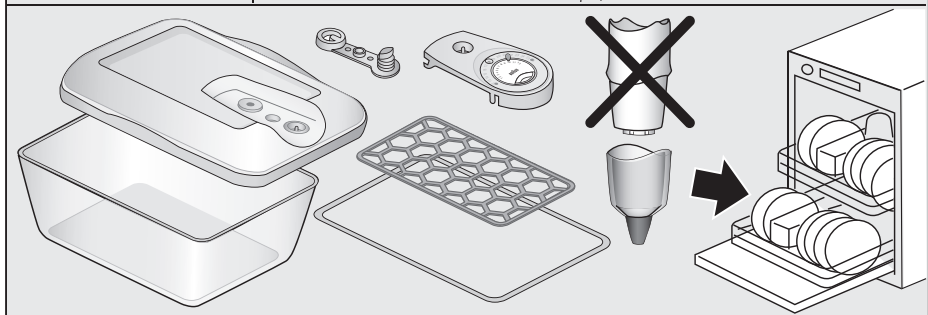
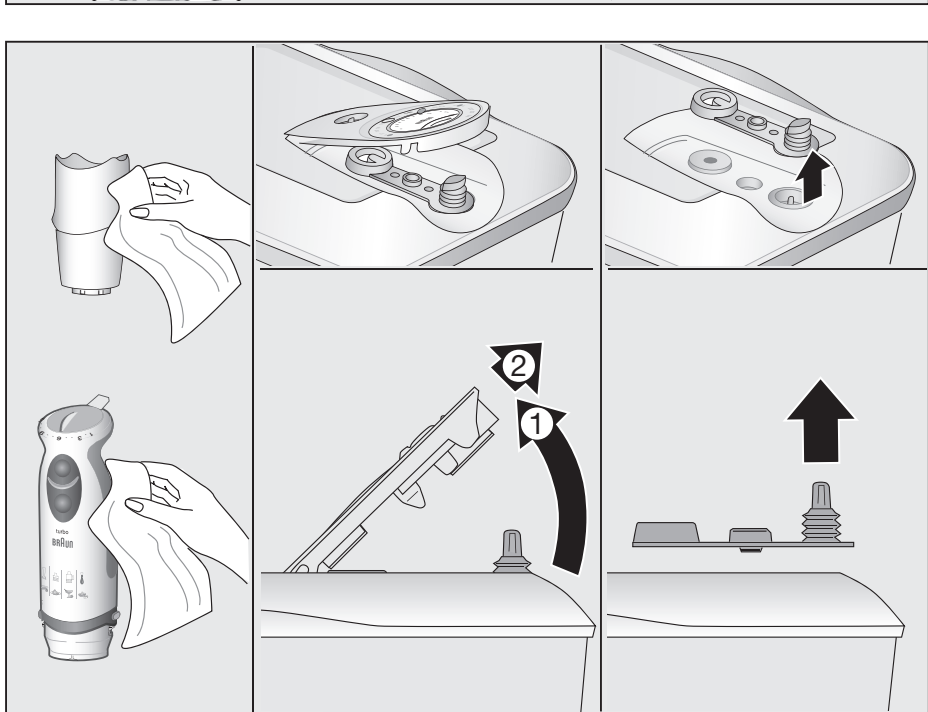
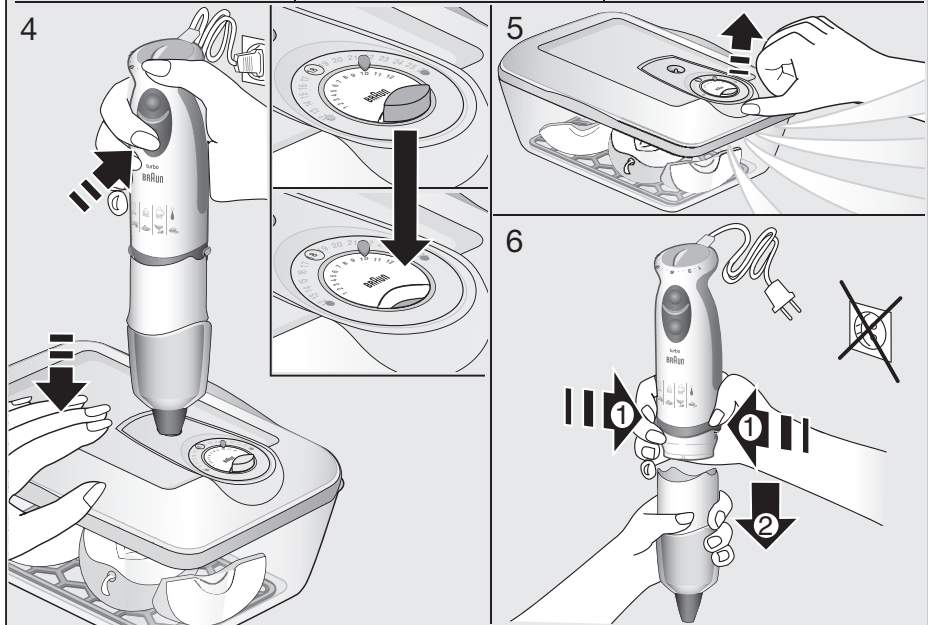
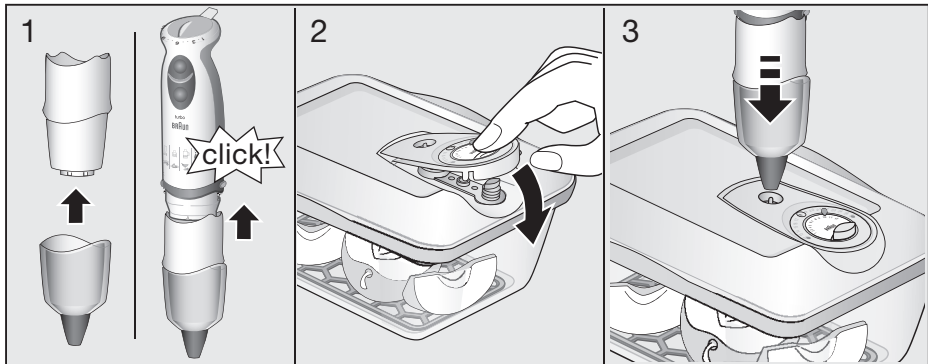

# 中文 MR5550 M CA V

## 多功能快速食品调理组合

### ——真空保鲜系统

恭喜您！您选购的这款产品可以帮您实现更长久的食物保质保鲜。使用真空泵将硬质容器中的空气吸出，将其保持在真空状态。因此，若要长久保持食物的新鲜、口味与品质，此产品是您的理想选择。

## 真空保鲜介绍

氧气是引起食物变质的主要原因之一。它会引起化学变化，降低食物的营养价值、维生素含量，并破坏食物的质感、色泽、风味及总体品质。而在真空状态下，食物的变质过程将会减缓。

博朗保鲜电器的设计初衷在于，当用户在烹制和保存食物时，为其提供最大程度的灵活性。因此，该产品是一款理想的日用电器。但若要达到最佳使用效果，需遵循几条一般防护措施。

## 注意

使用该电器前，请仔细阅读使用说明书。

- 真空保鲜并不能替代冷藏室或冷冻室的食物保存功用。因此，真空保鲜需严格符合各类食物的规定保存时间，尤其需注意食物的保存温度。此外，对于易变质食物，我们推荐的保存温度为-1至+7°C(依据BfR—德国联邦风险评估所做出的建议)。将食物保存在冷藏室的专用格内，即可达到此温度范围标准。
- 请勿在冷藏室内用此产品保存鲜鱼、海产品或肉馅。一般情况下，上述食品只能保存在冷冻室内。
- 在使用此产品抽出空气前，须先将食物冷却至室温(40°C以下)(以防发生真空沸腾)。
- 家用真空食物保存不同于工业真空食物包装，因为家中无法实现与之相同的预处理和微生物条件。
- 请不要将经过反复搅打、内含大量空气的食物(如搅打过的奶油、打泡的蛋清、甜点、奶油类食品等)置于真空状态。(该类食品在真空中极易膨胀，可能会损害机器。)
- FreshWare保鲜容器的盖子不适于微波加热。

## 提示和小窍门

- 将博朗FreshWare和真空泵组合使用，能使牛肉类食物的腌渍时间从几天缩短到几小时。为达到最佳效果，先将肉块浸没到佐料中，抽尽空气，而后立刻放入空气。将该过程重复两次以上，然后在非真空状态下将牛肉腌渍三个小时即可。
- 大米、扁豆、谷物和面粉类食物，若没有存放在冷藏室内，最终可能发霉或腐坏。在真空状态下，这种状况大大减少，食物能够保存地更长久、更优质。
- 真空处理过程从容器中抽出湿气，所以如果将食物，如脆饼、饼干、玉米片、水果干和干果，保存在干燥的真空状态下，会长时间保持酥脆且新鲜的口感。由于容器内的氧气含量减少，这些食物中的脂肪也得到了保护，不会流失。
- 应尽量减少真空密封容器的开关次数，以延长食物的可保存期。如果将大量近期不太食用的食品，如冷盘肉类，一并保存在真空状态下，即可最大程度地获益于真空保存容器。

## 说明

- A 电动机
- B 开关
- C 松解按钮
- D 真空泵
- E 泵体端盖
- F FreshWare (保鲜容器)
- G 盖子
- H 阀门盖
- I 泵接口
- J 日/月指示器
- K 真空指示器
- L 阀门密封口
- M 盖子密封圈
- N 托盘
- O 矩形容器

## 真空保鲜电器使用说明

- 1 将泵体端盖(E)与真空泵(D)连接，将电动机(A)插入真空泵，直至锁闭。
- 2 用盖子(G)盖住FreshWare(保鲜容器)，关闭阀门盖(H)。
- 3 将真空泵体与泵接口(I)连接。真空指示器(K)完全弹起，表明容器为非真空状态。
- 4 接通电器电源，将电器牢固地顶住盖子，开启开关(B)，抽尽空气。您按下开关的时间越长，真空指示器的下陷就越多。当真空指示器完全低于阀门盖时，表示空气已完全抽尽，此时需让泵体再持续工作数秒，以获取最佳真空状态。
- 5 要放入空气，打开阀门盖即可。开盖后，可听见清晰的声音，真空指示器也会弹起。
- 6 要从电动机上拆下真空泵，按住松解按钮(C)，然后拔起泵体即可。

## 注意

- 在操作过程中，若发生意外情况，导致空气抽尽失败，应检查所有零部件，确保其清洁性。
- 容器的装填程度须适量，装填物的高度与容器缘口的间距不得少于10mm。用冷冻室保存时，须确保大容器的装填物的高度与容器缘口的间距大于20mm。
- 若要用烤箱或微波炉加热容器，须取下盖子(G)和托盘(N)。
- 托盘(N)用来垫高食物，以防其与流出的液体接触。液体只会在托盘下方流动，所以不会与食物有任何接触。
- 鲜肉在真空状态下颜色会变暗。再与空气接触数分钟后，部分会恢复原有色泽。这是一种正常现象，不会对食物的品质造成任何影响。
- 保存过程中，只要真空指示器低于阀门盖的平面，就表示真空状态良好。

## 无法抽尽空气，实现真空状态时的处理方法

- 检查所有零部件，确保其清洁性。尤其是密封件(阀门和盖子密封圈)和盖子，应将其保持在完全无尘、无绒毛和无残留食物的状态下。在水下冲洗后，将其风干。
- 如果所有零部件清洁，但仍无法抽尽空气，则尝试重压盖子(G)，以确保其完全封闭。
- 由于泵体端盖采用了保护系统，只有在其插入泵接口后，真空泵才会工作。

## 博朗保鲜电器的优点

(通过德国弗朗霍夫研究所验证)参考冷藏室的食物保存条件: -1至+7°C

- I. 新鲜食物可以更长久的保鲜。

保存的食物	标准条件(天)	真空条件(天)
新鲜切片蔬菜 (如辣椒、小胡瓜)	6	10-12
新鲜水果 (如水果沙拉)	3	10
蘸酱(如鳄梨酱)	0	2
干脆食品 (如玉米饼、薯片)	3	30

- II. 保鲜电器所带来的显著优势就是，食物或预制肉制品的味道和新鲜度被完全封于容器内，将其质感，特别是味道长时间维持不变，具体保鲜时长如下。

微波炉加热套餐 (如烤宽面条)	15天*
白面包/黑面包	5天
黑麦面包	7天
奶酪	10-14天
冷盘肉类	7天

- III. 在真空状态下保存6天以后，维生素C的含量100%保留。而非真空保存条件只能保留65%。

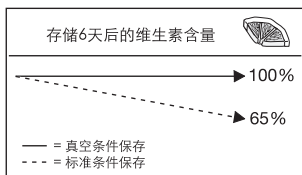

\*为了达到此保存时间，须按以下步骤操作：

将套餐在烤炉中充分加热，冷却到40°C以下，而后保存在真空条件中，切勿添加或去除任何东西。

## 清洁

首次使用博朗保鲜电器前，请对所有零部件进行清洁。只能用蘸水的湿布清洁电动机(A)和真空泵(D)。请勿将电动机或真空泵置于流水中，或将其浸泡在水中。其他所有零部件都可用洗碗机清洁。拆下阀门盖(H)、盖子密封圈(M)和阀门密封口(L)，将其分开置于洗碗机内清洁，也可在水下冲洗，然后风干。如要完全拆下阀门盖(H)，先将其抬起，然后拔出。

注意，切勿在洗碗机中过量使用洗洁精或去垢剂。

## 关于FreshWare(保鲜容器)

FreshWare容器由硬化硼硅酸盐玻璃制成，可以相互叠放。在微波炉、烤箱、冷冻室和洗碗机中，可以安全使用，因此用于食物保存以及二次加热和食用。

购买此产品，即配两个FreshWare，有四种尺寸可供选择：

- 0.9 | 矩形容器：用于保存少量食物制备、剩饭以及冷盘肉类和硬奶酪，效果甚佳。
- 3.1 | 矩形容器：为家人和朋友制备食物时的理想选择。能够用作菜盘，并用于保存大量食物。

我们还可供以下尺寸的FreshWare容器：

- 0.6 | 圆形容器：用于保存调味品、酱油、蘸酱、饼干、水果干等食物，效果甚佳。
- 1.2 | 圆形容器：用于保存干燥食物，效果甚佳，如牛奶什锦早餐、面粉、玉米片、饼干和水果干等。

从博朗电器库存商或博朗服务中心处，可购得上述任何尺寸的FreshWare容器。(不是所有国家都有供应)

如有变更恕不另行通知。

## 保修

我们为产品提供为期两年的保修，保修期从购买日开始计算。

在保修期内对于产品因材料或生产过程引起的各种瑕疵，我们会视情况更换零件或整个产品。

申请保修必须将本产品 and 能够证明购买日期的证据(购货发票)一起交给授权的Braun维修站，本产品附有一张授权的维修站名单。

请确认已将购货发票放置在安全的地方。

### 上述保修不包括以下内容：

- 由于使用不当而造成的产品损坏(如：使用错误的电流、电压，将产品插入不合适的插座，或者人为损坏等)。
- 正常使用引起的产品老化、磨损，但对产品的使用功能及价值影响不大。
- 按行业惯例定义的易损、易耗件。
- 如果产品经过未经授权的人员的修理，或产品使用了非本公司(Braun)的零件，保修期即终止。
- 非家庭使用(如工业、商业用)引起的损坏。
- 本保修适用于全球范围的所有经博朗公司及其指定供应商出售的博朗产品。并且在当地没有进口限制或其它法律条文限制本保修即可执行。
- 在保修期内提供的服务并不影响保修期按时结束，保修期中替换的零件或整机的保修服务与本产品的保修期同时终止。
- 除非确有法律规定，本公司不对其他任何要求负责。同供货商的销售合同中规定的各项权利不受此保修的影响。

如果需要保修或维修，请与当地的维修站，或就近的维修站联系。

固话免费咨询热线：800-820-1357

手机用户咨询热线：400-820-1357

原产国：波兰

进口商：博朗(上海)国际贸易有限公司

地址：上海市外高桥保税区菲拉路55号  
综合楼四层A部位

# English

Congratulations! You have purchased an appliance that will help you maintain the freshness and quality of your food for longer. By extracting and keeping air out, the vacuum pump creates vacuum conditions in rigid containers. This food preservation system is therefore perfect for retaining the freshness, taste and quality of your food for longer.

## About vacuum preservation

Oxygen is one of the main reasons why food deteriorates. By causing a chemical change, it reduces the nutritional value, level of vitamins, texture, colour, flavour and overall quality of the food. In vacuum conditions, the food deterioration process is slowed down.

The Braun fresh system has been designed to offer maximum flexibility to the user in the preparation and preservation of food. The system is therefore ideal for everyday use. There are, however, a few general safeguards that need to be followed to obtain the best results.

### Caution

**Please read through the use instructions carefully before using the appliance.**

- Vacuum preservation is not a substitute for food storage in the refrigerator or freezer. Therefore, the recommended storage times and especially temperatures for the respective food types need to be strictly observed. We further recommend a storage temperature of between -1 and +7 °C (based on the recommendations of the BfR – Federal Institute for Risk Assessment, Germany) for perishable food. This can be achieved by storing the food in the special cool compartments of the refrigerator.
- Do not use the vacuumiser to store fresh fish, seafood products or minced meat in the refrigerator. In general, these types of food should only be stored in the freezer.
- Always allow food to cool down to room temperature (below 40 °C) before applying the vacuum (to prevent a vacuum boiling effect).
- Household vacuum food storage cannot be compared with industrial vacuum food packaging. It is not possible to achieve the same kind of pre-treatment and microbiological quality in the home.
- Never preserve whipped food (e.g. whipped cream, beaten egg white, desserts, cream etc.) in vacuum conditions. This kind of food is likely to expand due to the vacuum, might enter the vacuum pump and damage it.
- The lids of the FreshWare containers are not microwave-proof and not oven-proof.

## Tips and tricks

- The combination of Braun FreshWare and the vacuum pump will make it possible to marinate such foods as beef in hours instead of days. For best results, pour marinade over the meat, then create a vacuum and release it right away. Repeat this procedure twice more and let the beef marinate without vacuum for three hours.
- Food such as rice, lentils, cereals and flour which are not preserved in the refrigerator can eventually become stale or spoiled. In vacuum conditions, this risk is significantly diminished with longer and better storage life as a consequence.

- The vacuum process extracts humidity from the containers. Dry food such as crackers, biscuits, cornflakes, dried fruits and nuts will therefore stay crispy and fresh for longer in a vacuum condition. Fats in these foods will be protected thanks to the reduction of oxygen inside the container.
- Avoid opening vacuum-sealed containers too often since this will reduce the durability of the food inside. You will obtain the best benefits from vacuum preservation if you vacuumise a large quantity of e.g. cold cuts which you are not intending to consume within the next few days.

## Description

- A Motor part
- B On/off switch
- C Release buttons
- D Vacuum pump
- E Pump cover
- F FreshWare
- G Lid
- H Valve lid
- I Pump coupling
- J Day/month indicator
- K Vacuum indicator
- L Valve seal
- M Lid seal
- N Tray
- O Rectangular container

## How to use your vacuum system

1. Attach the pump cover (E) to the vacuum pump (D) and insert the motor part (A) into the vacuum pump until it locks.
2. Place the lid (G) on the FreshWare container and close the valve lid (H).
3. Place the vacuum pump into the pump coupling (I). The vacuum indicator (K) is fully expanded, signalling that there is no vacuum inside the container.
4. Plug in the appliance, press firmly on the lid and operate the on/off switch (B) in order to create vacuum conditions. The longer you press the switch, the more the vacuum indicator retracts. A full vacuum has been created when the vacuum indicator is completely below the valve lid surface. Keep the pump working for a few more seconds for optimum vacuum conditions.
5. In order to release the vacuum, simply open the valve lid. Upon opening, the freshness sound will be heard and the vacuum indicator will move up.
6. To remove the vacuum pump from the motor part, press the release buttons (C) and pull off.

### Please note:

- In the unlikely case that a vacuum is created, but then gets lost within a short period of time, ensure that all parts are clean.
- Do not fill a container more than 10 mm below the brim. For storage in the freezer, please assure that the big containers are not filled more than 20 mm below the brim.
- Before using the containers in an oven or microwave, make sure you remove both the lid (G) as well as the tray (N).
- The tray (N) is designed to protect food from exuded liquids during storage. Liquids will flow under the tray avoiding contact with the food.



- Raw meat will become darker under vacuum conditions. After a few minutes in contact with air again, it will partly recover its natural colour. As this is a normal process, there will be no impact on the quality of the food.
- During storage, vacuum conditions are acceptable as long as the vacuum indicator stays in line with the valve lid surface.

## What to do if vacuum cannot be generated

- Ensure all parts are clean. The sealing elements (valve and lid seal) and the lid especially have to be completely free from dust, fluff or food particles. Rinse them under water and let them air-dry.
- If all parts are clean and the vacuum still cannot be generated, press firmly on the lid (G) to make sure that it is completely closed.
- Thanks to a protection system in the pump cover, the vacuum pump will only work if it is inserted in the pump coupling.

## Benefits of the Braun fresh system

(validated by Fraunhofer Institute, Germany)  
Refers to storage in a refrigerator: between -1 and +7 °C

- I. Fresh food is kept fresh for longer.

Storage	Standard (days)	Vacuum (days)
Fresh vegetables, sliced (e.g. peppers, courgettes)	6	10-12
Fresh fruit (e.g. fruit salad)	3	10
Dips (e.g. guacamole)	0	2
Crisps (e.g. tortilla/potato chips)	3	30

- II. A significant benefit of the fresh system is that the taste and freshness of food or prepared meals can be sealed inside the container, maintaining current texture and especially taste up to the storage times listed below.

Oven prepared meals (e.g. lasagne)	15 days*
White/brown bread	5 days
Dark bread	7 days
Cheese	10-14 days
Cold cuts	7 days

- III. After 6 days under vacuum conditions, vitamin C content is maintained 100%. Without vacuum storage, only up to 65% is maintained.

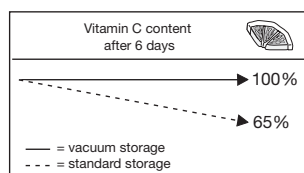

- \* To achieve this storage time, proceed as follows: Heat your meal well in the oven, let

it cool down below 40 °C and vacuumise it without adding or removing anything.

## Cleaning

Before you use the Braun fresh system for the first time, rinse all parts thoroughly.

Clean the motor part (A) and the vacuum pump (D) with a damp cloth only. Do not hold the motor part nor the vacuum pump under running water, nor immerse them in water. All other parts can be cleaned in the dishwasher. Remove the valve lid (H), lid seal (M) and valve seal (L) to clean them separately in the dishwasher or rinse them under water and let them air-dry. To remove the valve lid (H) completely, lift and pull out.

Be careful not to use excessive detergent or descaler in your dishwasher.

## About FreshWare

The stackable FreshWare containers are made from hardened borosilicate glass and are microwave, oven, freezer and dishwasher safe. Therefore, they can be used for food preservation as well as reheating and serving.

Your starter set includes two of the four FreshWare sizes available:

- 0.9 l rectangular container: Ideal for food preparation in smaller quantities and for the preservation of leftovers as well as cold cuts and hard cheese.
- 3.1 l rectangular container: Ideal for the preparation of food for your family and friends. Can be used as a serving dish and to store larger quantities of food.

We also offer the following FreshWare containers:

- 0.6 l round container: Ideal for the storage of food such as spices, sauces, dips, biscuits, dried fruit etc.
- 1.2 l round container: Ideal for the storage of dry food such as muesli, flour, corn-flakes, biscuits, dried fruit etc.

The entire FreshWare range is available from all good stockists of Braun appliances or from Braun Service Centres (not available in all countries).

Subject to change without notice.

## Internet:

[www.braun.com](http://www.braun.com)  
[www.service.braun.com](http://www.service.braun.com)

Braun GmbH  
Frankfurter Straße 145  
61476 Kronberg/Germany

98813841/XII-08  
China/GB